



## Encryption and Decryption of a Chaotic Fractional Order Financial System

Malek Karimian<sup>a,\*</sup>

<sup>a</sup>Department of mathematics, university of Ilam, Ilam. Iran

### Abstract

This paper presents the anti-synchronization of two non-identical chaotic fractional order financial system with disturbance observe (FOFSDO), such that the anti-synchronization is discussed with new parameters and disturbance in slave system by using nonlinear active control technique. The stability of scheme is proved by applying Lyapunov stability method for error system. The result of anti-synchronization with disturbance is applied in cryptography. Numerical examples and simulations analysis show the applicability and validity of the scheme and considered system.

Keywords: Chaotic, Anti-synchronization, Secure Communication.

2020 MSC: 13D45, 39B42, .

©2022 All rights reserved.

### 1. Introduction

Recently the application of dynamic systems in various sciences including, electromagnetic waves, quantitative finance, engineering-biology, dielectric polarization, etc [38, 40, 41, 42, 43], is rapidly increasing. In the last two decades, there have done some useful research on fractional-order financial systems(FOFS), which we refer to as some of them.

Investigating stable dynamics of a fractional-order chaotic financial system whit parameter switching is given by Marius-F. Danca et al [44]. Sara Dadras, Hamidreza Momeni [35] have investigated control of a fractional-order economical system with sliding mode scheme. Zhen Wang, Xia Huang [34, 39] presented synchronization of a chaotic fractional-order economical system with active control and, control of on uncertain fractional-order economic system via adaptive sliding mode method [32] have studied finite-time stabilizing a fractional-order chaotic financial system with marcet confidence. Ayub Khan and Arti Tyagi [36] have designed disturbance observer-based adaptive sliding mode hybride projective synchronization of identical fractional-order financial systems. Norely Aguila-Camacho et al [37] have investigated Lyapunov functions for fractional-order systems. In 2016, analysis and circuit simulation of a novel nonlinear fractional incommensurate order financial system, was reported [33]. Malek Karimian , Bashir Naderi and Yousef Edrisi-Tabriz[46] presented the Application of a fractional-order financial system with disturbance in encryption and decryption. Malek Karimian, Bashir Naderi and Yousef Edrisi-Tabriz[1] presented the Sensitivity analytic and synchronization of a new fractional-order financial system. Tacha et al [31] presented the determining the chaotic behavior in a fractional-order finance system with negative parameters. Zhe

\*Corresponding author

Email address: [malekkarimian@gmail.com](mailto:malekkarimian@gmail.com) (Malek Karimian)

Received: November 3, 2022 Revised: November 10, 2022 Accepted: November 21, 2022

Zhang et al [45] presented a novel stability criterion of time-varying delay fractional-order financial systems based a new functional transformation Lemma.

The research on the anti-synchronization of the dynamic systems using different method has been carried out by many researchers, which we refer to below. In 2011, Diyi Chen et al [27] have investigated chaotic synchronization and anti-synchronization for a class of multiple chaotic systems via a sliding mode control scheme. Waffa Jawaada et al [26] have studied robust active sliding mode anti-synchronization of hyperchaotic systems with uncertainties and disturbances. Anti-synchronization of uncertain chaotic systems with adaptive terminal sliding mode control, was reported in [30], and intermittent anti-synchronization of two identical hyperchaotic chua systems via impulsive control scheme was presented by Hong-LiLi et al [28]. Al-Sawalla and Noorani [25, 29] have studied chaos and adaptive reduced-order for anti-synchronization of uncertain chaotic systems with unknown parameters. Also some other scheme such as projections, active control, phase ant anti-phase and reduced-order method are used for anti-synchronization of fractional-order chaotic systems [21, 20, 22, 23, 19].

Recently for transmitting of information the chaotic systems used as a applicable method, such that the information in transmitter merge with a chaotic signal. The sending information signal via public canal recovered by a chaotic receiver. The most famous method for transmitting and recovering information chaos masking, chaos modulation, and chaos shift keying. In chaos masking, the signal is added directly to the transmitter, in modulation the signal injected into the transmitter, and in shift keying the chaotic signal as a binary signal mapped into the transmitter. In these three cases, the information signal recovered by a receiver whit applying synchronization or anti-synchronization between the chaotic transmitter and receiver [13, 17, 10]. Development of chaos masking approach, chaotic shift keying, and modulation method can be found in [9, 12, 11, 16, 8, 14].

Recently, several fractional or integer-order chaotic systems have been introduced. The synchronization and anti-synchronization of these systems via methods such as adaptive control, sliding-mode and feedback control have been discussed such that these systems are without disturbance. Some manuscripts used these systems for secure communication [7, 5, 3, 4, 16, 6].

In this paper, the anti-synchronization between the FOFS are investigated using nonlinear active control technique in the presence of new parametric, different initial conditions and the disturbance observer. By using the Lyapunov stability, sufficient condition for achieving anti-synchronization of the chaotic FOFSDO via active control is obtained. The disturbance can be have major role in anti-synchronization and its applications. One application of anti-synchronization is encryption and decryption. In the most previous works of researchers, for encryption and decryption used the systems without disturbance. We use the slave system with disturbance for encryption and decryption, and show the results by numerical simulation.

## 2. Description of system

In this section, we review some fundamental definitions of fractional calculus. Also, we present stability theorems, properties of fractional-order dynamical systems and describe the used financial fractional order system.

Definition 2.1. [24] The  $q_{th}$  fractional order Caputo derivative of function  $G(t)$  is as follow:

$${}^c D_t^q G(t) = D^{-(m-q)} D^{(m)} G(t) = \frac{1}{\Gamma(m-q)} \int_0^t (t-\zeta)^{m-q-1} G^{(m)}(\zeta) d\zeta, \quad (2.1)$$

where  $m-1 < q \leq m$ ,  $m \in \mathbb{N}$ ,  $q \in \mathbb{R}^+$ ,  $\Gamma(q) = \int_0^\infty t^{q-1} e^{-t} dt$ .

Some properties of fractional order differential equations are:

- The linear characteristic of the Caputo fractional-order derivative

$${}^c D_t^q [c_1 G_1(t) + c_2 G_2(t)] = c_1 {}^c D_t^q G_1(t) + c_2 {}^c D_t^q G_2(t), \quad (2.2)$$

where  $c_1, c_2$  are constants and  $G_1, G_2$  are functions of  $t$  blue [18].

- If  $G(t)$  is a constant function then

$${}^c D_t^q G(t) = 0, \quad (2.3)$$

where  $0 < q \leq 1$  [18].

Lemma 2.2. [37] Assume that  $G(t) \in \mathbb{R}$  is a continuous and differentiable function, then we have

$$\frac{1}{2}({}^c D_t^q G^2(t)) \leq G(t) {}^c D_t^q G(t), \quad (2.4)$$

where  $0 < q < 1$ .

Theorem 2.3. [15] Autonomous system  $D^q x = Ax$ ,  $x(0) = x_0$  is asymptotically stable if the following condition is satisfied

$$|\arg(\lambda(A))| > \frac{q\pi}{2},$$

where  $0 < q < 1$  and  $\lambda(A)$  is the eigenvalue of matrix  $A$ . Also, the system  $D^q x = Ax$  is stable if and only if  $|\arg(\lambda(A))| \geq \frac{q\pi}{2}$ , and those critical eigenvalues that satisfy  $|\arg(\lambda(A))| = \frac{q\pi}{2}$ , have geometric multiplicity of one.

Consider the following FOFS [33]:

$$\begin{cases} D^{q_1} x &= z + (y - a)x \\ D^{q_2} y &= 1 - by - |x| \\ D^{q_3} z &= -x - cz, \end{cases} \quad (2.5)$$

where  $x, y$  and  $z$  are rate, the investment demand, and the price index respectively. The constant parameters  $a > 0$ ,  $b > 0$  and  $c > 0$  are saving amount, the cost per investment and the elasticity of demand, respectively and  $0 < q_i \leq 1 (i = 1, 2, 3)$  is the fractional derivative order finance system. Figure 1 shows that the lowest value of  $q_i (i = 1, 2, 3)$  for which the system remains chaotic is commensurate order  $q_1 = q_2 = q_3 = 0.79$  of the FOFS (2.5). Consider the new parameters as a  $a = 0.7$ ,  $b = 0.1$ ,  $c = 0.9$  [1] and the different initial condition  $(x(0), y(0), z(0)) = (3, -3.5, 1.5)$  [31].

## 2.1. Subsection title

In this section, the anti-synchronization between two different FOFSDO is studied.

The fractional-order master system as

$$\begin{cases} D^{q_1} x &= z + (y - a)x \\ D^{q_2} y &= 1 - by - |x| \\ D^{q_3} z &= -x - cz, \end{cases} \quad (2.6)$$

and also, as the slave system as

$$\begin{cases} D^{q_1} x_1 &= z_1 + (y_1 - a)x_1 + u_1(t) + d_1(t) \\ D^{q_2} y_1 &= 1 - by_1 - x_1^2 + u_2(t) + d_2(t) \\ D^{q_3} z_1 &= -x_1 - cz_1 + u_3(t) + d_3(t), \end{cases} \quad (2.7)$$

where  $u(t) = (u_1, u_2, u_3)^T$  is the controller and  $d_i (i = 1, 2, 3)$  unknown disturbance observers. So the anti-synchronization error dynamic system between (2.7) and (2.6) is as follow

$$\begin{cases} {}^c D_t^{q_1} e_1(t) &= e_3 + y_1 x_1 + y x - a e_1 + u_1(t) + d_1(t) \\ {}^c D_t^{q_2} e_2(t) &= 2 - b e_2 - x_1^2 - |x| + u_2(t) + d_2(t), \\ {}^c D_t^{q_3} e_3(t) &= -e_1 - c e_3 + u_3(t) + d_3(t). \end{cases} \quad (2.8)$$

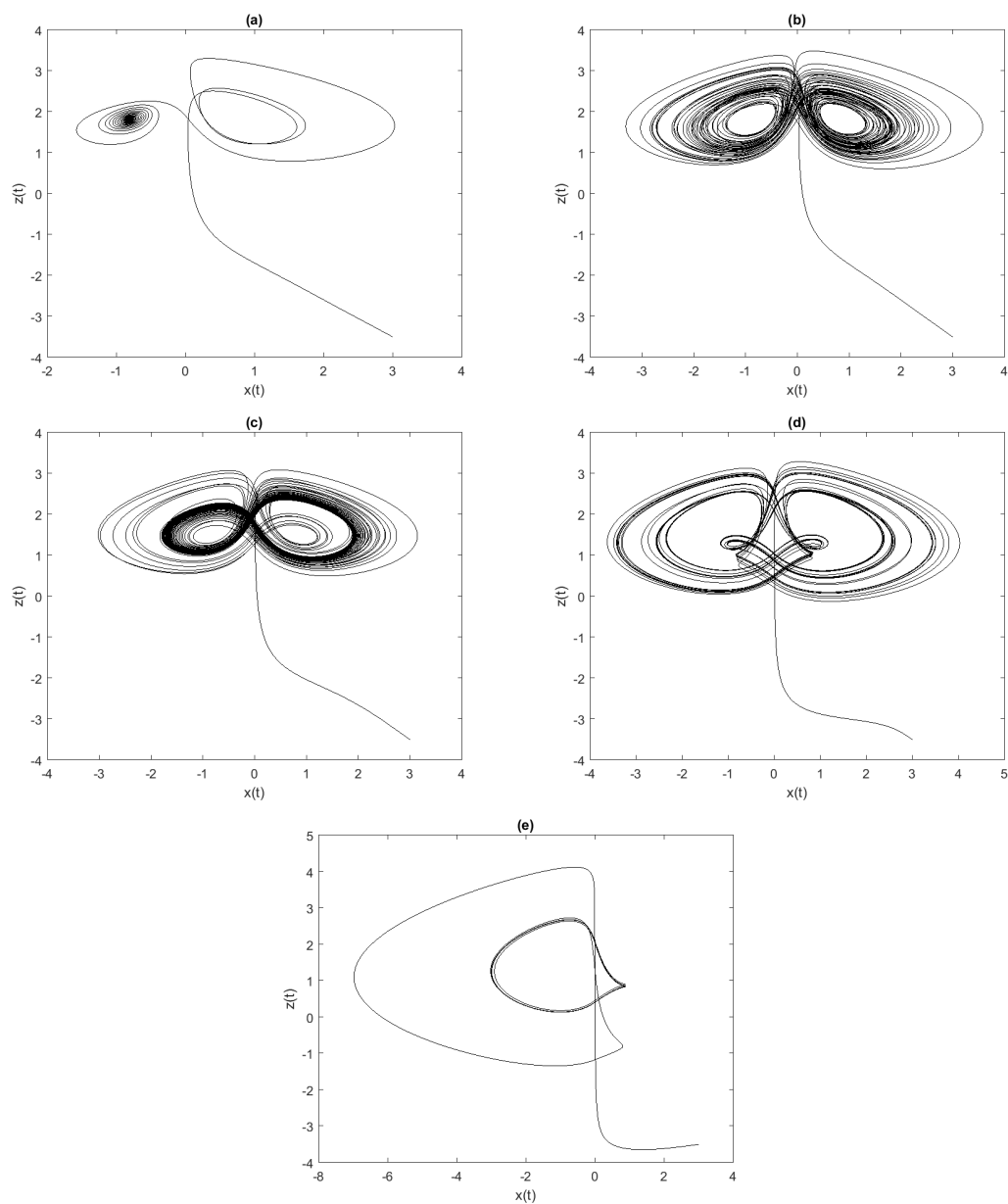

Figure 1: The phase portrait of fractional order finance system (2.5) for the commensurate orders at  $q_1 = q_2 = q_3 = q$ . (a) $q=0.78$ , (b) $q=0.79$ , (c) $q=0.86$ , (d) $q=0.95$ , (e) $q=1$ .

The  $u_1, u_2$  and  $u_3$  controllers are given by as follows:

$$\begin{cases} u_1(t) = -y_1x_1 - yx + w_1(t) - d_1(t) \\ u_2(t) = -2 + x_1^2 - |x| + w_2(t) - d_2(t) \\ u_3(t) = w_3(t) - d_3(t), \end{cases} \quad (2.9)$$

where  $w_1, w_2$  and  $w_3$  the control inputs, we have

$$\begin{cases} w_1(t) = (a - 1)e_1 - e_3 \\ w_2(t) = (b - 1)e_2 \\ w_3(t) = e_1 + (c - 1)e_3. \end{cases} \quad (2.10)$$

By substituting (2.10) in (2.9) and then substituting (2.9) in (2.8), we get the error system as

$$\begin{cases} D^{q_1}e_1 = -e_1 \\ D^{q_2}e_2 = -e_2 \\ D^{q_3}e_3 = -e_3. \end{cases} \quad (2.11)$$

By define the Lyapunov function  $V(e)$  as follow

$$V(e) = \frac{1}{2}(e_1^2 + e_2^2 + e_3^2), \quad (2.12)$$

according Lemma (2.2) and property (2.2), we have

$$D^{q_i}V(e) \leq e_1D^{q_1}e_1 + e_2D^{q_2}e_2 + e_3D^{q_3}e_3. \quad (2.13)$$

By substituting (2.11) in (2.13), we get

$$D^{q_i}V(e) \leq -e_1^2 - e_2^2 - e_3^2 < 0. \quad (2.14)$$

The error system (2.8) is asymptotically stable. So the anti-synchronization between the systems (2.6) and (2.7) is archived.

### Numerical simulation

In this subsection, we provide numerical simulation for illustrating the proposed method. The Numerical solution method is used to solve the systems. In the numerical simulation, we choose the new parameters as  $a = 0.7, b = 0.1, c = 0.9$  and the initial conditions of the master and slave systems are taken as  $(x(0), y(0), z(0)) = (3, -3.5, 1.5), (x_1(0), y_1(0), z_1(0)) = (-4.5, 1, -6.5)$  respectively. Thus the initial error are  $(-1.5, -2.5, 5)$ . Disturbance observer as  $d_1 = 0.1 \sin(200t), d_2 = 0.2 \cos(200t), d_3 = 0.3 \cos(300t)$ . Figure 2 (a-c) shows the anti-synchronization between the master system (2.6) and the slave system (2.7) at  $q_1 = q_2 = q_3 = 0.83$ . Figure 3 (a-d) shows the anti-synchronization error functions  $e_1, e_2$  and  $e_3$  for the commensurate orders  $q_1 = q_2 = q_3 = q = 0.83, q = 0.9, q = 0.96, q = 1$ , respectively. The error converges to zero at approximate  $t = 4$  as shown in figure 3. Figure 4 shows the anti-synchronization between the master system (2.6) and the slave system (2.7) at  $q_1 = q_2 = q_3 = 0.79$ . Figure 5 (a-d) anti-synchronization error functions  $e_1, e_2$  and  $e_3$  are shown. Also, figure 5(a-d) shows the error is converges to zero at approximate time  $t = 4$ .

### 3. Histogram analysis

the encryption process is shown in Figure 9 in the implemented implementation, a  $256 \times 256$  pixels size 12-bit gray image including Figure 7 and Figure 8 shapes in considered as the main images.

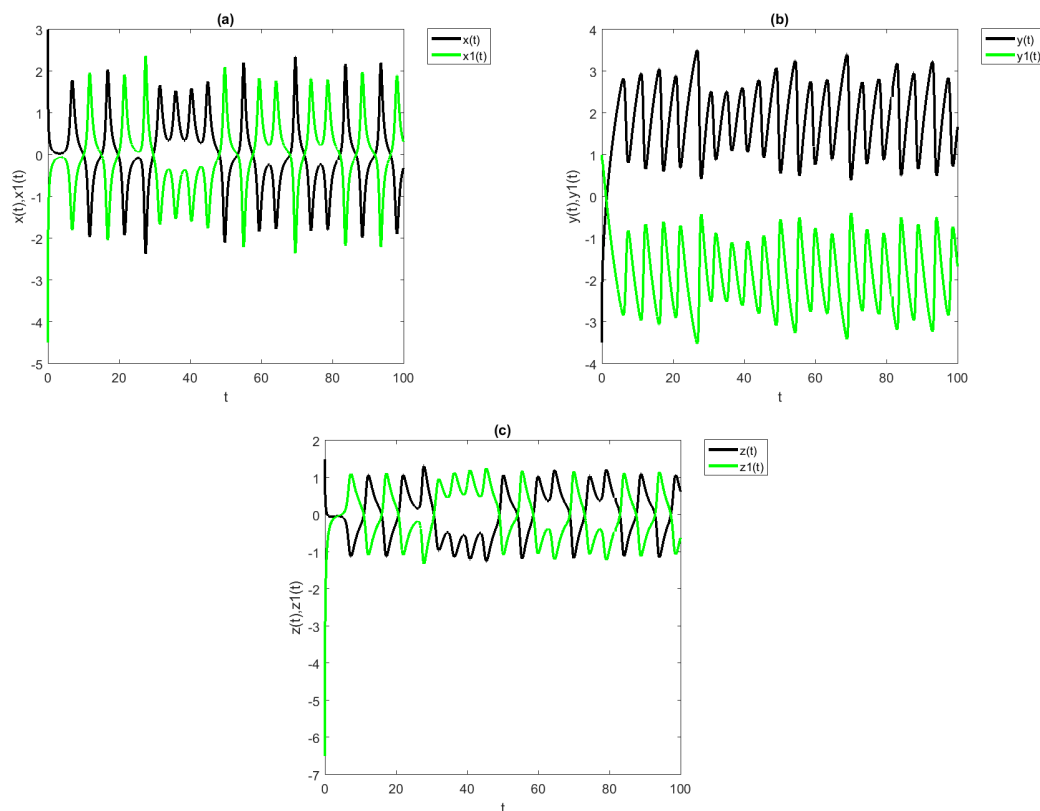

Figure 2: Depicts the phase portraits of anti-synchronization of system (2.6) and (2.7).

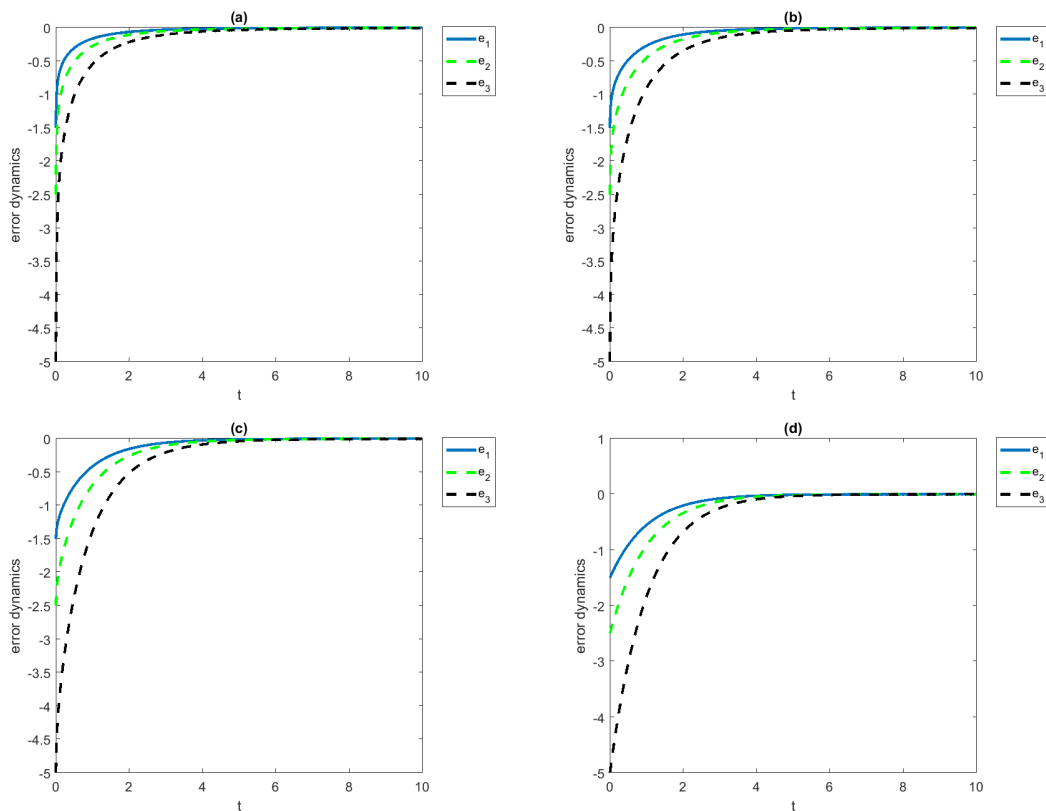

Figure 3: anti-synchronization error for the commensurate orders, (a)  $q_1 = q_2 = q_3 = q = 0.83$ , (b)  $q = 0.9$ , (c)  $q = 0.96$ , (d)  $q = 1$ .

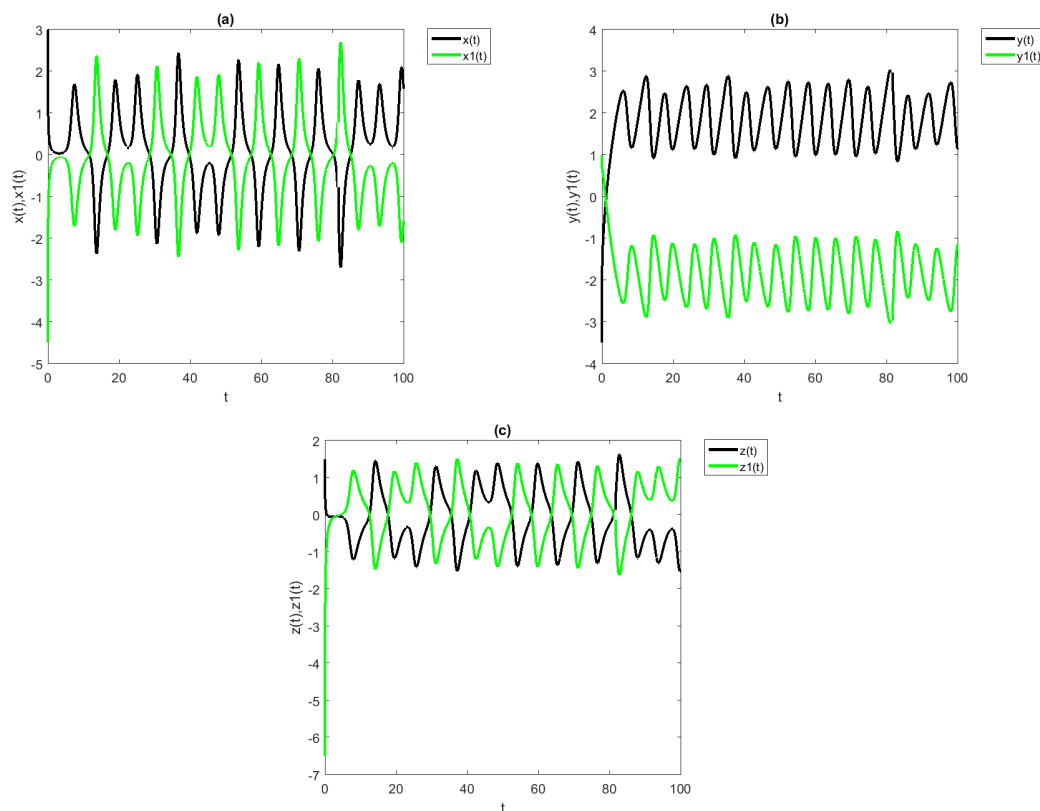

Figure 4: Depicts the phase portraits of anti-synchronization of the master system (2.6) and the slave system (2.7).

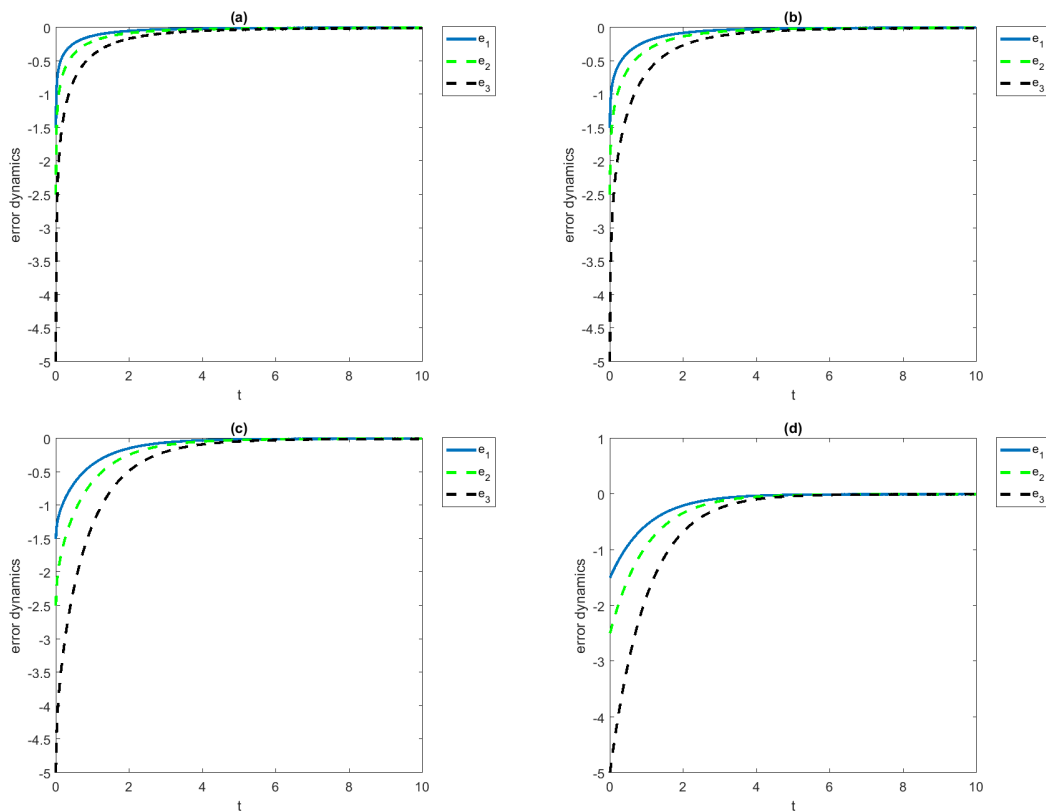

Figure 5: anti-synchronization error for the commensurate orders, (a)  $q_1 = q_2 = q_3 = q = 0.79$ , (b)  $q = 0.86$ , (c)  $q = 0.95$ , (d)  $q = 1$ .

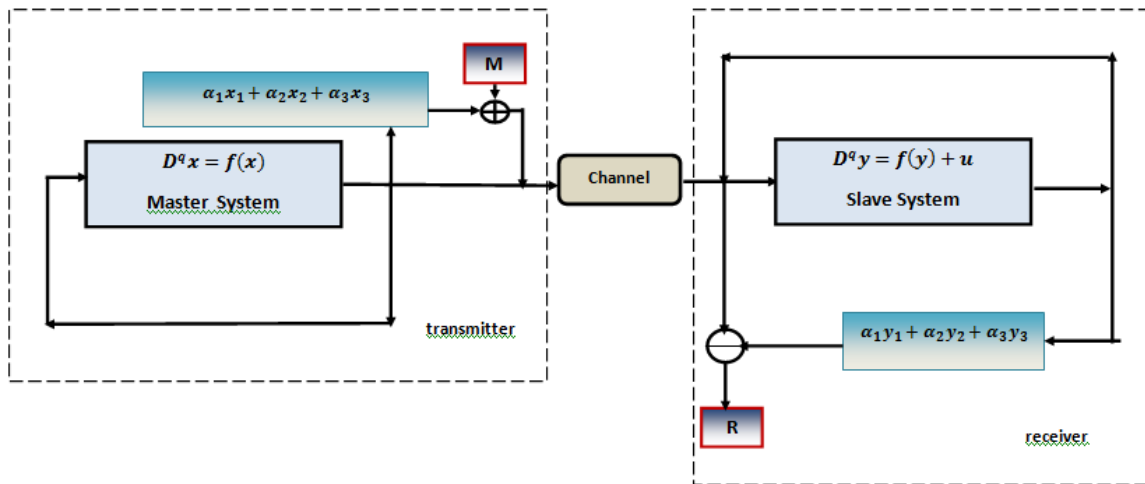

Figure 6: Diagram of secure communication based on anti-synchronization.



Figure 7: Penguin image, from left to right: original image, encrypted penguin, decryption penguin

#### 4. Application of financial chaotic system with disturbance in cryptography

In this section, we investigate the masking secure communication scheme based on anti-synchronization of two fractional-order chaotic finance systems such that the slave system have disturbance. The diagram of secure communication methods by two fractional-order financial chaotic systems is shown in figure 6. The used system at the transmitter side are systems 2.6 and 2.7 respectively.

At the transmitter side, the original message  $M(t)$  is masked by the chaotic signal. The masked message is shown with  $T(t)$  and is defined

$$T(t) = M(t) + hx(t). \tag{4.1}$$

$M(t)$  must be well chosen in a way that it can be successfully masked by  $hx$ . Otherwise, the original message  $M(t)$  is multiplied by a scaling factor [2] is used for resizing the original message. The resulting signal  $T(t)$  from the transmitter is sent to the receiver via a public channel. By results in section ??, the anti-synchronization will be achieved by designed controllers. If  $T_c$  is time greater than  $T_s$  ( $T_s$  is the synchronization and anti-synchronization time), it will be suitable for transfer and recovery. The received signal by the receiver is recoverable with following equation on anti-synchronization:

$$R(t) = T(t) + hx_1 \cong M(t).$$

Because, according to the concept of anti-synchronization, we have:

$$R(t) = M(t) + hx(t) + hx_1(t) = M(t) + h(x(t) + x_1(t)) = M(t) + he_1(t) \cong M(t).$$

the proposed secure communication scheme is established by two finance fractional-order chaotic systems as shown in figures 6. Figure 7 shown the decryption and encryption of penguin image based on proposed algorithm.



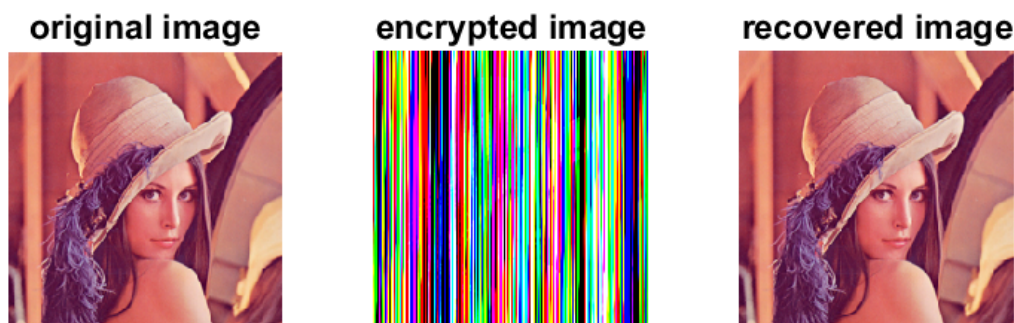

Figure 8: Lena image, from left to right: original image, encrypted Lena, decryption Lena

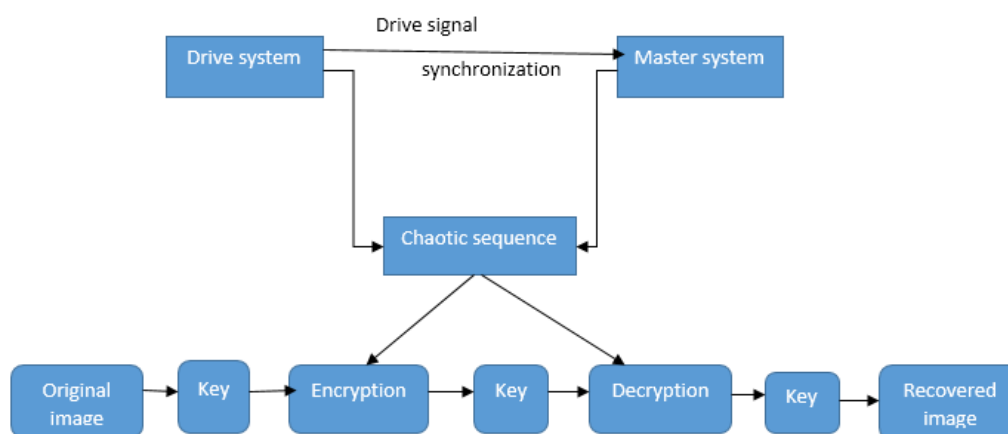

Figure 9: Block diagram of chaotic system in encryption

## 5. Conclusions

In this paper, we used active control method for anti-synchronization of the FOFSDO with new parameters and the different initial-conditions. The stability between two the FOFSDO has been investigated using the appropriate Lyapunov function. The obtained results of anti-synchronization of systems with disturbance used for secure communication via masking method. The results show, that the designed controller have effectiveness for anti-synchronization and secure communication with disturbance in slave system. Numerical simulations confirm theoretical result and the proposed method.

## References

- [1] M. Karimian, B. Naderi, Y. Edrisi Tabriz, Application of a afractional-order financial system with disturbance in encryption and decryption. *Int. J. Nonlinear Anal. Appl.* In press, 1-14, (2022). 1, 2
- [2] C. J. Cheng, Robust synchronization of uncertain unified chaotic systems subject to noise and its application to secure communication, *Applied Mathematics and Computation*, 219 (2012) 2698-2712. 4
- [3] F. Yua, C. Wang, Secure communication based on a four-wing chaotic system subjectto disturbance inputs. *Optik*, 125, 5920-5925 (2014). 1
- [4] M. F. Haroun, A. T. Gulliver, A new 3D chaotic cipher for encrypting two data streams simultaneously. *Nonlinear Dyn.*, 81, 1053-1066 (2015). 1
- [5] X. Wang, M. Wang Adaptive synchronization for a class of high-dimensional autonomous uncertain chaotic systems. *Int. J. Mod. Phys. C*, 18(3), 399-406 (2007). 1
- [6] Y. Xu ., H. Wang, Y. Li, B. Pei, Image encryption based on synchronization of fractional chaotic 1
- [7] C. Tao, X. Liu, Feedback and adaptive control and synchronization of a set of chaotic and hyperchaotic systems. *Chaos Solitons Fract.*, 32(4), 1572-1581 (2007). 1

- [8] M. Rafael, nez-Guerran, J. Juan. Montesinos Garcia, Sergio M. Secure communications via synchronization of Liouvillian chaotic systems, *Journal of the Franklin Institute*, 353 (2016) 4384-4399. [1](#)
- [9] K. M. Cuomo, A. V. Oppenheim, S. H. Strogatz, Synchronization of Lorenz-based chaotic circuits with applications to communications. *IEEE Trans Circuits Syst*, 40, 626-33 (1993). [1](#)
- [10] U. Parlitz, L. O. Chua, L. Kocarev, Ks. Halle, A. Shang. Transmission of digital signals by chaotic synchronization. *Int. J. Bifur. Chaos*, 2, 973-977 (1992). [1](#)
- [11] H. Dedieu, M. P. Kennedy, M. Hasler, Chaos shift keying: modulation and demodulation of a chaotic carrier using self-synchronizing Chua's circuits. *IEEE, Trans Circuits Syst*, 40, 634-642 (1993). [1](#)
- [12] T. Yang, L.O. Chua, Secure communication via chaotic parameter modulation. *IEEE Trans. Circuits Syst. I*, 43, 817-819 (1996). [1](#)
- [13] L. Kocarev K. S. Halle, K. Eckert, L. O. Chua, U. Parlitz, Experimental demonstration of secure communication via chaotic synchronization. *Int J Bifur Chaos*, 2, 709-713 (1992). [1](#)
- [14] B. Naderi, H. Kheiri, A. Heydari, R. Mahini. Optimal synchronization of complex chaotic t-systems and its application in secure communication. *Journal of Control, Automation and Electrical Systems*, 27(4), 2016, 379–390. [1](#)
- [15] D. Matignon, Stability results for fractional differential equations with applications to control processing. *Computational Engineering in systems Applications, IMACS, IEEEESMC, Lille, France, Vol, 2*, pp. 963-968 (1996). [2.3](#)
- [16] B. Naderi, H. Kheiri, Exponential synchronization of chaotic system and application in secure communication. *Optik - International Journal for Light and Electron Optics*, 127(5), 2407–2412 (2016). [1](#)
- [17] Boutayeb M., M. Darouach, H. Rafaralahy, Generalized state observers for chaotic synchronization and secure communication. *IEEE Trans Circuits Syst I*, 49, 345-346 (2002). [1](#)
- [18] Li. Changpin, D. Weihua, Remarks on fractional derivatives. *App. Math. Comput.* 187, 777-784(2007) [2, 2](#)
- [19] P. Muthukumar, P. Balasubramaniam, K. Ratnavelu, A novel cascade encryption algorithm for digital images based on anti-synchronization fractional-order dynamical systems. *Multimed Tools Appl*, DoI 10.1007/s11042-016-4052-4(2016) [1](#)
- [20] M. Sirvastava, S. K. Agrawal, S. Das, Reduced-order anti-synchronization of the projections of the fractional-order hyperchaotic and chaotic systems. *Control European Journal of Physics*, DoI 10.2478/s11534-013-0310-5(2013) [1](#)
- [21] H. Taghvafar, G. H. Erjaee, Phase and anti-phase synchronization of fractional-order chaotic systems via active control. *Commun Nonlinear Sci Numer Simulat* 16, 4079-4088(2011) [1](#)
- [22] Sirvastava, M., Ansari, S.P., Agrawal, S. K.: Anti-synchronization between identical and non-identical fractional-order chaotic systems using active control method. *Nonlinear Dyn.* DoI 10.1007/s11071-013-1171-0(2013) [1](#)
- [23] V. K. Yadav, S. K. Agrawal, M. Sirvestava, S. Das, Phase and anti phase synchronization of fractional-order hyperchaotic systems with uncertainties and external disturbances using nonlinear active method. *Int. J. Dynam. Control.* DoI 10.1007/s40435-015-0186-X (2015). [1](#)
- [24] B. Bandyopadhyay, S. Kamal, Stabilization and control of fractional-order systems a sliding mode approach. DoI 10.1007/s978-3-319-08621-7, springer(2015). [2.1](#)
- [25] M. M. Sawalla, M. S. M. Noorani, Chaos reduced-order anti-synchronization of chaotic systems with fully unknown parameters. *Commun Nonlinear Sci Numer Simulat* 17, 1908-1920(2012) [1](#)
- [26] W. Jawadda, M. S. Noorani, M. Al-Sawalla, Robust active sliding mode anti-synchronization of hyperchaotic systems with uncertainties and external disturbances. *Nonlinear Analysis: Real world Applications*, 13, 2403-2413(2012) [1](#)
- [27] D. Chen, R. Zhang, X. Ma, S. Liu, Chaotic synchronization and anti-synchronization for a novel class of multiple chaotic systems via a sliding mode control scheme. *Nonlinear Dyn*, DoI 10.1007/s11071-011-0244-7 (2012). [1](#)
- [28] H. Li Li, Y. L. Jiang, Z. L. Wang, Anti-synchronization and intermittent anti-synchronization of two identical hyperchaotic chua systems via impulsive control. *Nonlinear Dyn.* DoI 10.1007/s11071-014-1711-8 (2014). [1](#)
- [29] M. M. Sawalla, M. S. M. Noorani, Adaptive reduced-order anti-synchronization of chaotic systems with fully unknown parameters. *Commun Nonlinear Sci Numer Simulat* 15, 3022-3034 (2010). [1](#)
- [30] Li. Li. Fang, R. Li, Adaptive terminal sliding mode control for anti-synchronization of uncertain chaotic systems. *Nonlinear Dyn.* DoI 10.1007/s11071-013-1017-2 (2013). [1](#)
- [31] O. I. Tacha, M. J. Pacheco, E. Serrano, I. N. Stouboulos, V. T. Pham, Determining the chaotic behavior in a fractional-order finance system with negative parameters. *Nonlinear Dyn*, 10.1007/s11071-018-4425-5 (2018). [1, 2](#)
- [32] B. Xin, J. Zhang, Finite-time stabilizing a fractional-order chaotic financial system with market confidence. *Nonlinear Dyn*, DoI 10.1007/s11071-014-1749-7 (2014). [1](#)
- [33] A. Hajipour, H. Tavakoli, Analysis and circuit simulation of a novel nonlinear fractional incommensurate order financial system. *Optic* 127, 10643-10652 (2016). [1, 2](#)
- [34] Z. H. Wang, X. Huang, Synchronization of a chaotic fractional order economical system with active control. *Procedia Engineering* 15, 516-520 (2011). [1](#)
- [35] S. Dadras, H. R. Momeni, Control of a fractional-order economical system Via sliding mode. *Physical A* 389, 2434-2442 (2010). [1](#)
- [36] A. Khan, A. Tyagi, Disturbance observer-based adaptive sliding mode hybrid projective synchronization of

- identical fractional-order financial system. Paramana- J. phys. DoI 10.1007/s12043-018-1555-8 (2018). [1](#)
- [37] N. A. Camacho, D. Mermoud, J. A. Gallegos, Lyapunov functions for fractional order system. *Common Nonlinear sci Numer simulate* 19, 2951-2957 (2014). [1](#), [2.2](#)
- [38] M. Ichise, Y. Nagayangi, T. Kojima, An analog simulation of noninteger order transfer functions for analysis of electrode process. *J. Electroanal. Chem.* 33, 253-265 (1971). [1](#)
- [39] Zh. Wang, X. Huang, H. A. Shen, Control of an uncertain fractional-order economic system via adaptive sliding mode. *Neurocomputing* 83, 83-88 (2012). [1](#)
- [40] N. Laskin, Fractional market dynamics. *Phys. A* 287, 482-492 (2000). [1](#)
- [41] T.T. Hartley, C. F. Lorenzo, Dynamics and control of initialized fractional-order systems. *Nonlinear Dyn* 29, 201-233 (2002). [1](#)
- [42] R. Hifer, Applications of fractional calculus in physics. P. 472. World scientific, Hackensack (2001). [1](#)
- [43] R. C. Koeller, Application of fractional calculus to the theory of viscoelasticity. *J. Appl. Mech* 51, 299-307 (1984). [1](#)
- [44] M. F. Danca, R. Garrappa, K.S. Wallace, G. Chen, Sustaining stable dynamics of a fractional-order chaotic financial system by parameter switching computers and mathematics with Applications. 66, 702-716(2013) [1](#)
- [45] Zh. Zhang, J. Zhang, F. Cheng, F. Liu, A novel stability criterion of time-varying delay fractional-order financial systems based a new functional transformation Lemma. *International Journal of Control, Automation and systems* 17(X), 1-10 (2019). [1](#)
- [46] M. Karimian, B. Naderi, Y. Edrisi Tabriz, Sensitivity analytic and synchronization of a new fractional-order financial system. *Computational Methods for Differential Equations* Vol. 9, No. 3, pp. 788-798 (2021). [1](#)